

Structure of microfiche

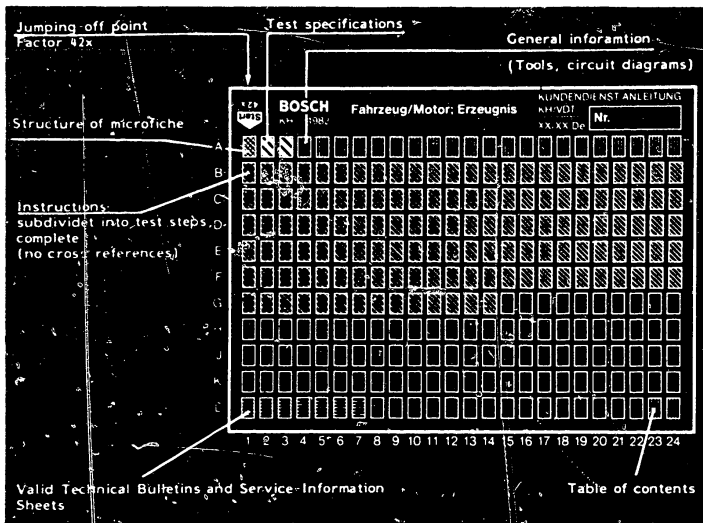

1. Read from left to right

2. Title of microfiche (appears on each coordinate)

E 16	Product/assembly/test step	
	Vehicle/engine	

Coordinate

3. Limits of section

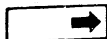

Beginning

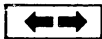

Mid-section



End

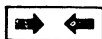

One-page section

4. References to relevant test steps in test specifications; coordinate e.g. C6

C6

A1

Repair and testing



1. Test specifications

Safety circuit:

Response voltage	32.5...33.0 V
Time delay	$1.6 \text{ sec} \leq t \leq 2 \text{ sec}$

Blocking voltage:

Response voltage	31.5...32.0 V
------------------	---------------

Regulated voltage:

Generator speed	2900...3100 min ⁻¹
Load current	25...35 A
Regulated voltage	Regulator
	0 192 003 011 28.4...28.6 V
	0 192 003 012 29.5...29.6 V

Generator current limitation:

Generator speed	2900...3100 min ⁻¹
Regulated voltage	26.5...27.5 V
Generator current	Regulator
	0 192 003 011 150...155 A
	0 192 003 012 130...135 A

A2

Test specifications

Transistor regulator 0 192 003 011 / 012



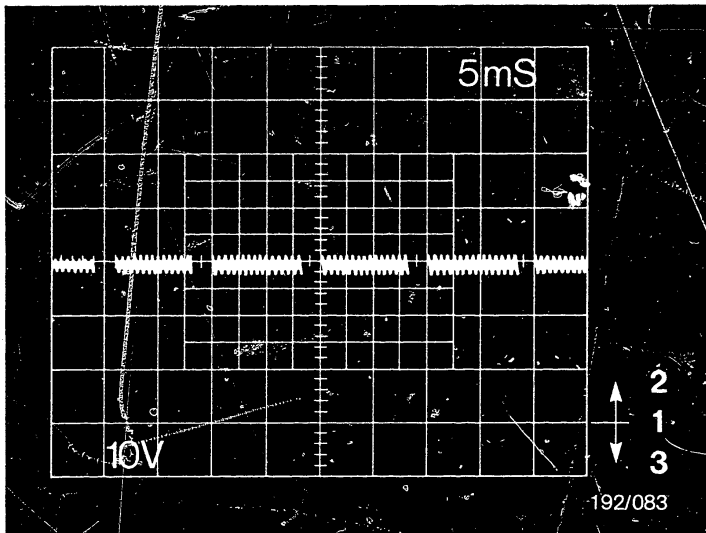

- 1 = Base line on oscilloscope
 2 = Negative range
 3 = Positive range } Input inverted

The illustration shows the O.K. oscilloscope display for the regulated voltage

at generator speed	2900...3100 min ⁻¹
load current	25...35 A
regulated voltage for regulator	
0 192 003 011	28.4...28.6 V
for regulator	
0 192 003 012	29.5...29.6 V

A3

Test specifications

Transistor regulator 0 192 003 011 / 012



2. Test equipment, lubricants

2.1 Test equipment

Measuring oscilloscope

(Resolution 25 MHz
smallest measuring range
5mV/cm time-delay cable)

Commercially available

(e.g. Hameg 412)

Voltmeter

(Measuring range up to 40 V)

Commercially available

Ohmmeter

(Measuring range 1 M Ω)

(e.g. Bosch Electric-
Tester ETE 014.00
Part No. 0 684 101 400)

Ammeter

(Measuring range up to 160 A)

Voltage stabilizer

Commercially available

(50 V min. 2 A)

(e.g. Zentro Electric)

Resistance decade

Commercially available

2.2 Lubricants

Thermo-lubricant

Part No. 5 942 860 003



3. Type code

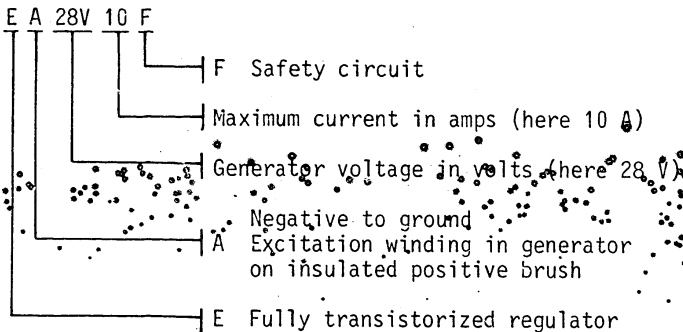

A5

Type code

Transistor regulator 0 192 003 011 / 012



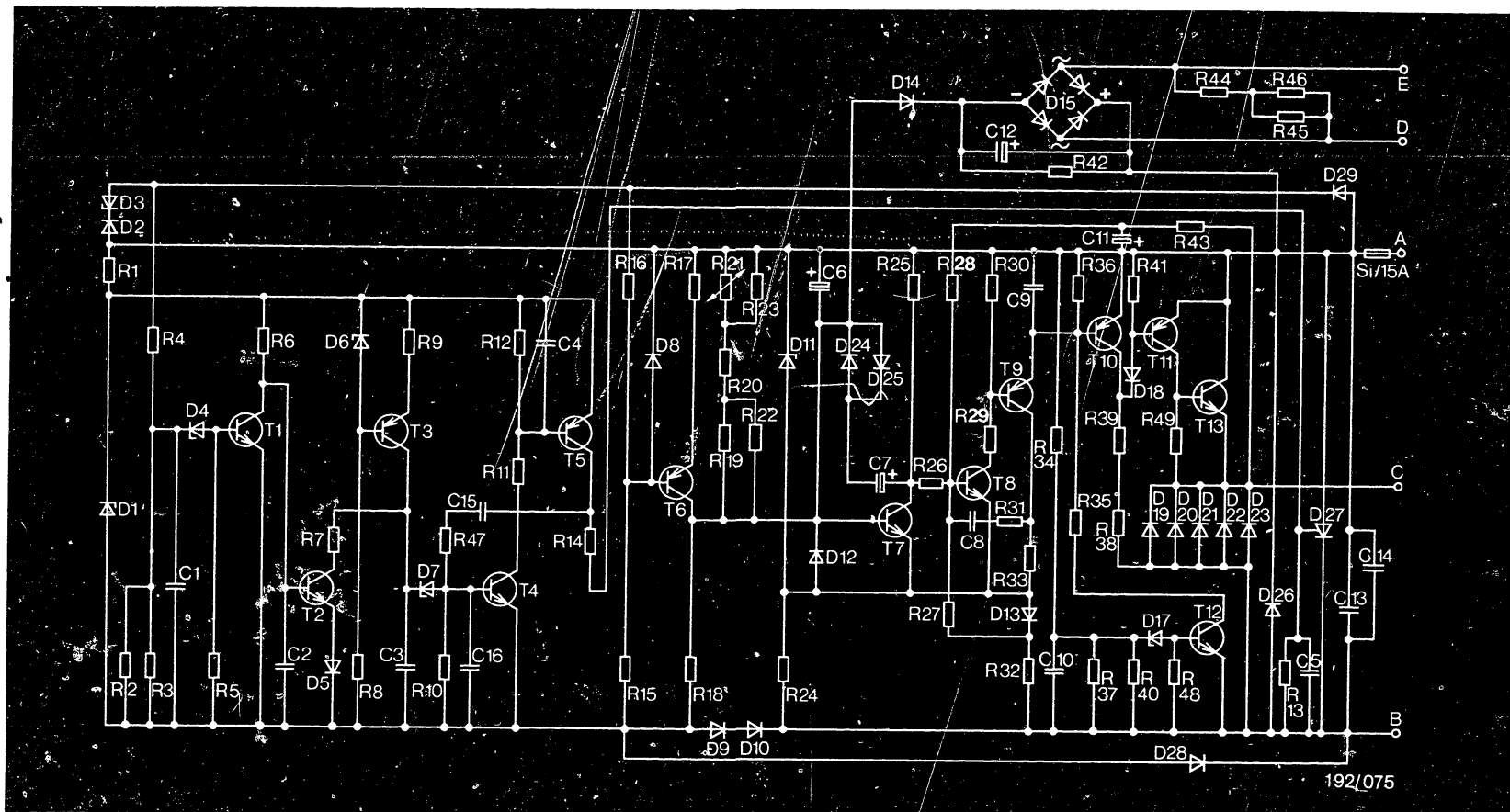

4. Internal circuit diagram of transistor regulator 0 192 003 011 (EA 28 V 10 F)

A
 A/
 B
 C } Leads to plug with pins
 D
 E

A6

Internal circuit diagrams
 Transistor regulator 0 192 003 011 / 012



A7

Internal circuit diagrams
 Transistor regulator 0 192 003 011 / 012



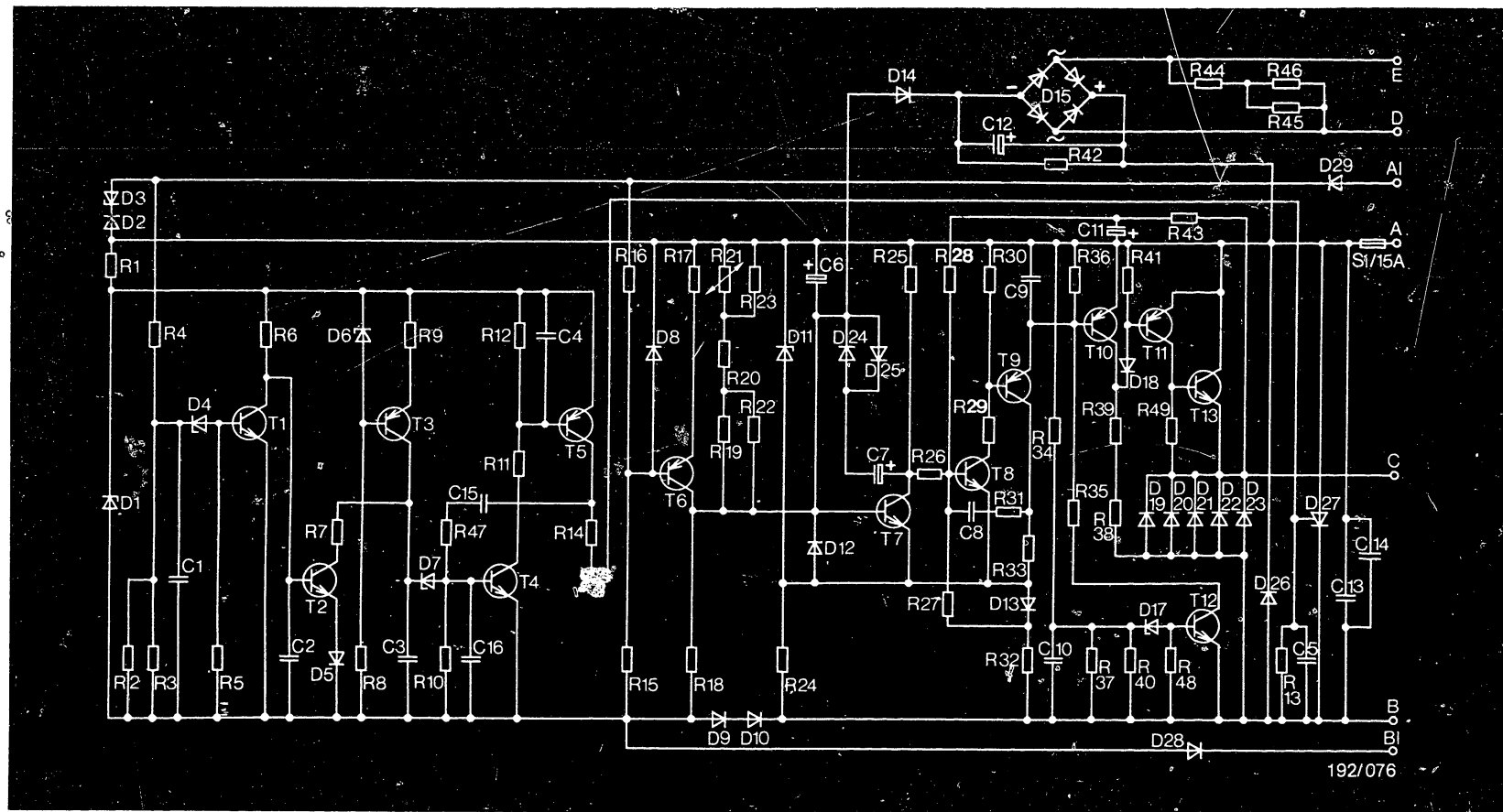

4.1 Internal circuit diagram of transistor regulator 0 192 003 012 (EA 28 V 10 F)

A
A/
B
C
D
E } Leads to plug with pins

A8

Internal circuit diagrams
Transistor regulator 0 192 003 011 / 012



A9

Internal circuit diagrams
Transistor regulator 0 192 003 011 / 012



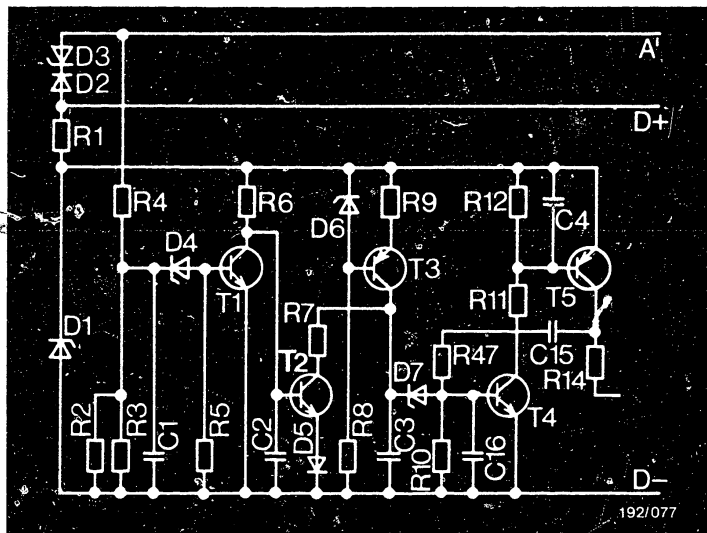

5. Functional description

5.1 Safety circuit

The supply voltage is limited with unidirectional-breakdown diode D1. The response voltage of the safety circuit is set with the trimmer R2/R3. Together with unidirectional-breakdown diode D6 and resistors R8/R9, transistor T3 forms a source of current which charges the capacitor C3. The delay time of the safety circuit can be changed with resistor R9 or unidirectional-breakdown diode D7. If voltage D+ is smaller than the voltage U_F set at the safety circuit, transistor T1 blocks, transistor T2 conducts and thus prevents capacitor C3 from charging; transistors T4 and T5 block. If voltage D+ is greater than U_F , transistor T1 conducts, and transistor T2 blocks. Capacitor C3 charges.

A10

Functional description

Transistor regulator 0 192 003 011 /012



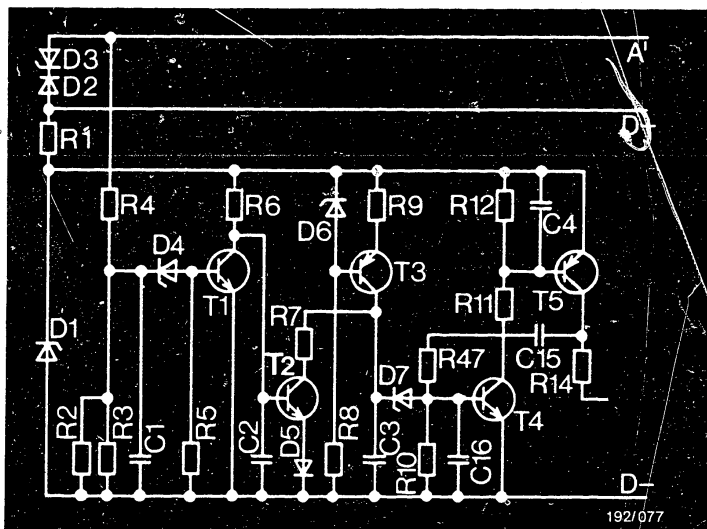

When the voltage of unidirectional-breakdown diode D7 and the base-emitter voltage of transistor T4 are reached, transistors T4 and T5 conduct; thyristor D27 fires and fuse S1 blows.

If the duration of the overvoltage is shorter than the time delay, transistor T1 blocks and capacitor C3 is discharged through transistor T2.

A11

Functional description

Transistor regulator 0 192 003 011 / 012



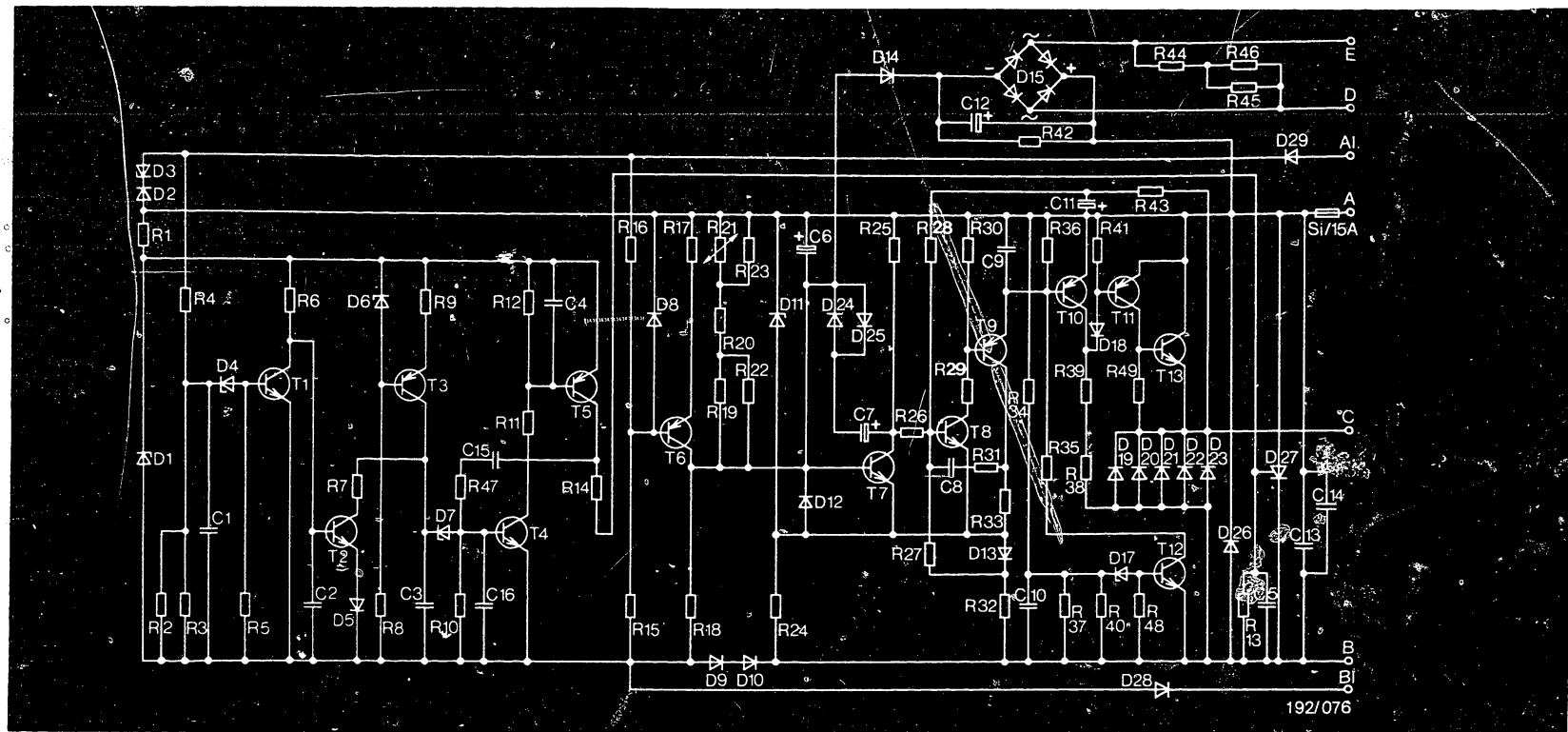

5.2 Regulated voltage

The reference voltage for the regulator is formed by unidirectional-breakdown diode D11. The regulated voltage is trimmed with resistors R19/R22. If voltage D_+ rises, the base of transistor T7 becomes more negative than the emitter and transistor T7 blocks. The rectifier of the current transformer is connected to the base of transistor T7 through the decoupling diode D14. The base voltage of transistor T7 is changed depending on the value of resistors R45/R46. Capacitors C6, C7 and C12 prevent regulated voltage oscillations. Decoupling diode D12 prevents mutual influencing of the reference voltage and the trimming voltage of voltage divider R19/R22. Depending on the voltage drop of the leads between generator and battery, transistor T6 causes a change in the regulator trimming (only with O12 with battery sensing).

A12

Functional description

Transistor regulator 0 192 003 011 / 012



A13

Functional description

Transistor regulator 0 192 003 011 / 012

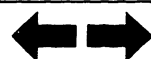

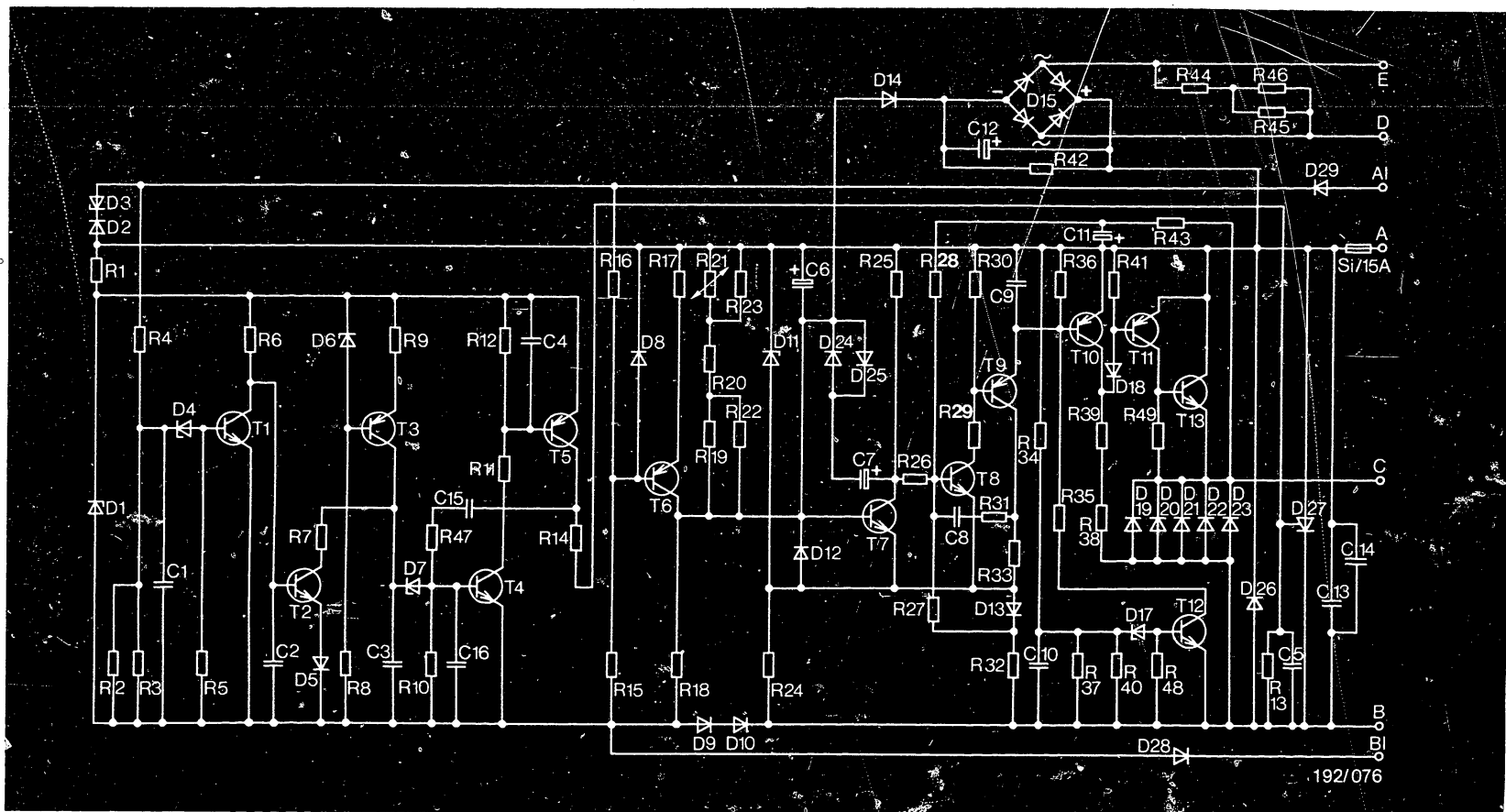

The voltage drop of these leads is determined through the battery sensing terminals A' and B'. The regulator is able to compensate a total of approx. 2 V voltage drop on the positive and negative leads. Unidirectional-breakdown diode D3 and diode D2 as well as diodes D9/D10 serve to measure the voltage drop. Diodes D2, D9/D10 additionally protect the sensing leads against overloading in the event of a drop in the D+ or D- lead. Diodes D28 and D29 serve as protection against incorrect polarity of A' and B'.

A14

Functional description

Transistor regulator 0 192 003 011 / 012

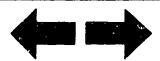

A15

Functional description

Transistor regulator 0 192 003 011 / 012



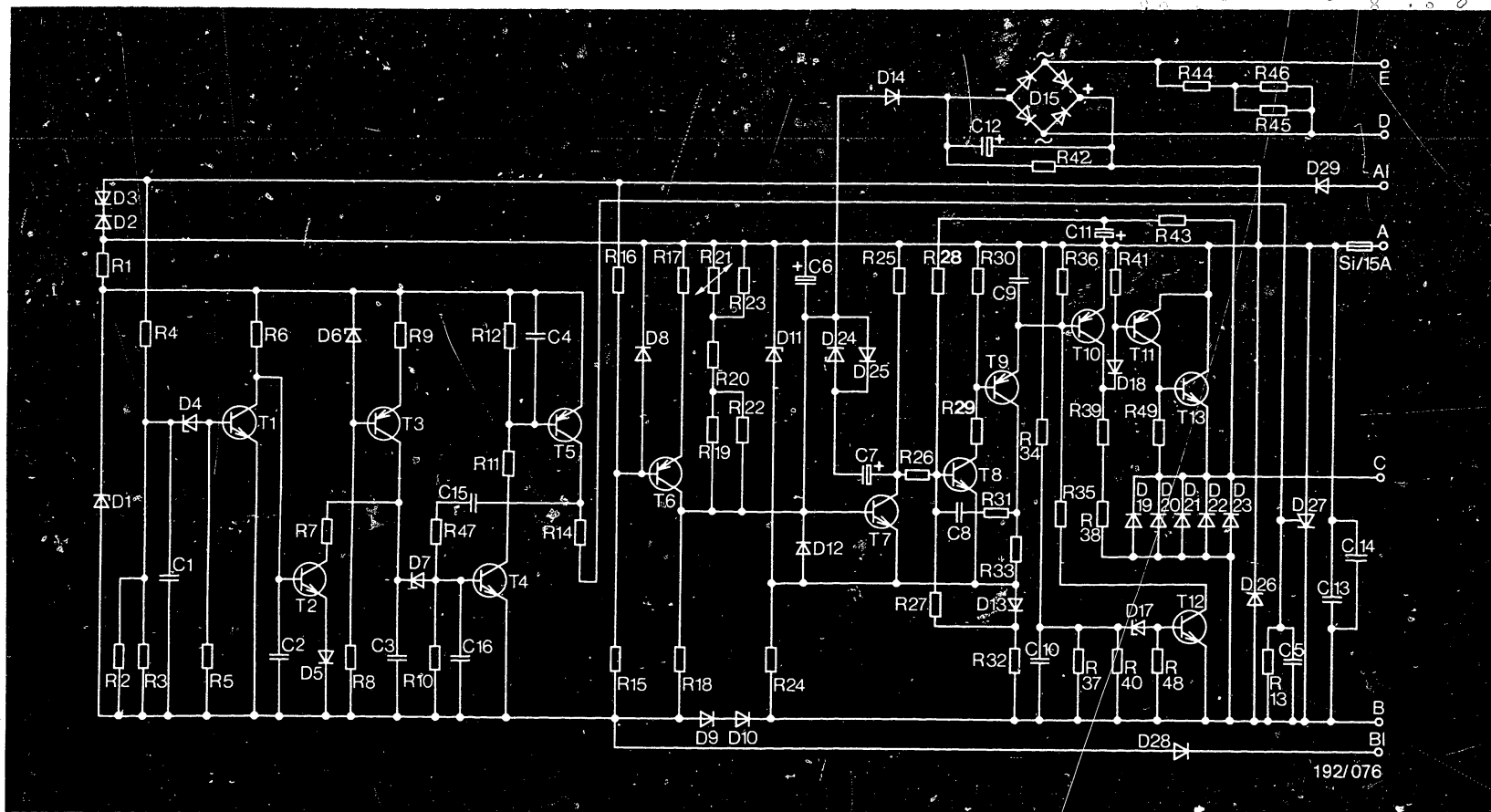

5.3 Regulated frequency

The trigger stage is influenced with transistors T8/T9 as a function of the switching condition of transistor T7. Resistors R28/R43 and capacitor C11 smooth the regulator characteristic and reduce the tendency of the regulator to oscillate.

A16

Functional description

Transistor regulator 0 192 003 011 / 012

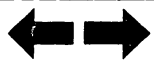

A17

Functional description

Transistor regulator 0 192 003 011 / 012



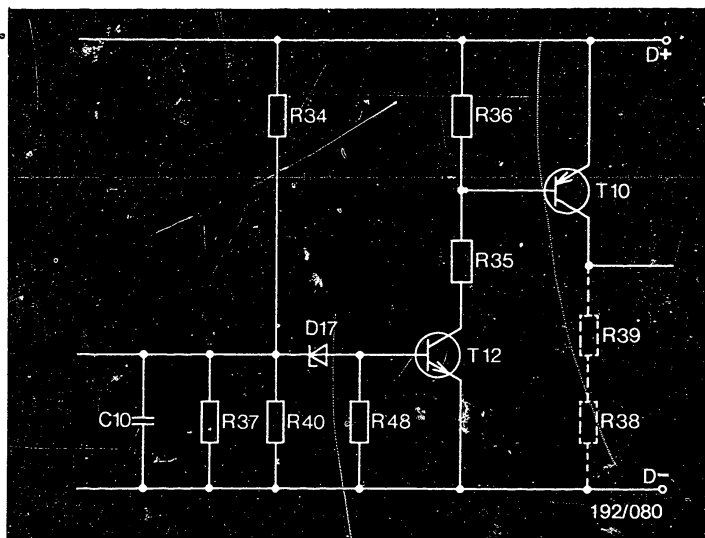

5.4 Blocking circuit

The blocking circuit with transistor T12 ensures that the output stage is always safely blocked in the case of load cut-off without battery. Diode D26 serves as incorrect-polarity protection for the regulator. The intervention of this blocking circuit is such that it has no influence on the regulated voltage, but is below the response voltage of the safety circuit.

A18

Functional description

Transistor regulator 0 192 003 011 / 012



6. Trouble-shooting

6.1 Visual examination

By means of a visual examination check whether any of the components has an immediately recognizable defect. Do not repair burnt-off connections, but replace the entire printed circuit board.

6.2 Insulation testing

Using an ohmmeter check whether power transistor T13 is properly insulated from the heat sink and the regulator housing. Resistance min. 1 M Ω . Replace insulating washers if defective. Do not tighten the fastening screws of the transistor too much so as to ensure that the base of the transistor does not become bent. This would lead again to insulation damage.



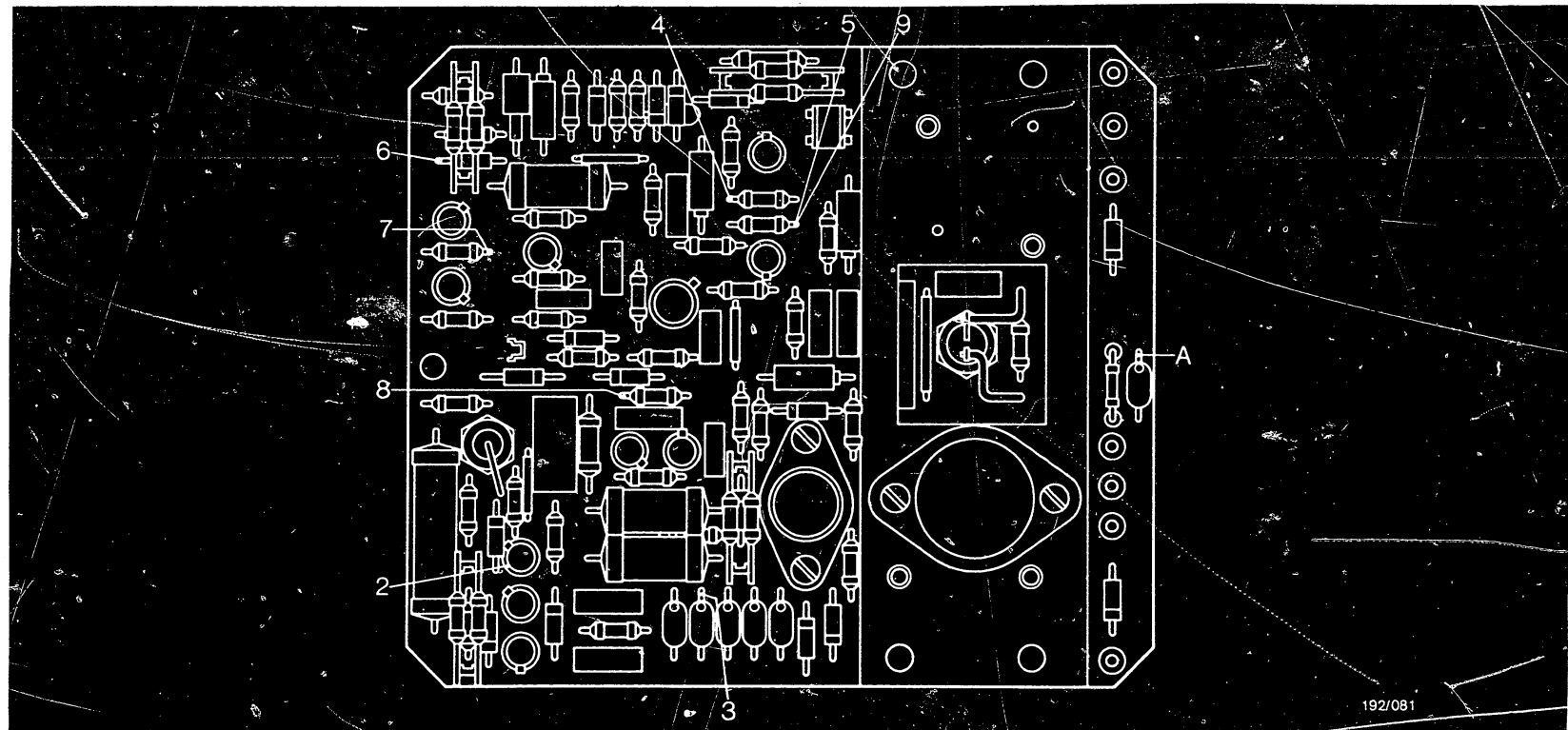

192/081

6.3 Trouble-shooting with oscilloscope

Operate the oscilloscope only via an isolating transformer. In order to quickly locate a fault it is useful to test the regulator with an oscilloscope. Connect the regulator to the generator and a well charged battery. Drive the generator at 3000 min^{-1} . Set the load with load resistors to $25 \dots 35 \text{ A}$. Tap the individual test points with the oscilloscope, beginning with test point 3. Compare the oscilloscope displays with Figs. 1...7. If, in the course of testing, a faulty

oscilloscope display is obtained, the components lying outside the range of the O.K. oscilloscope displays are individually tested while referring to the information on possible faults. Replace a defective component with a new component of the same type.

B2

Trouble-shooting

Transistor regulator 0 192 003 011 / 012



B3

Trouble-shooting

Transistor regulator 0 192 003 011 / 012



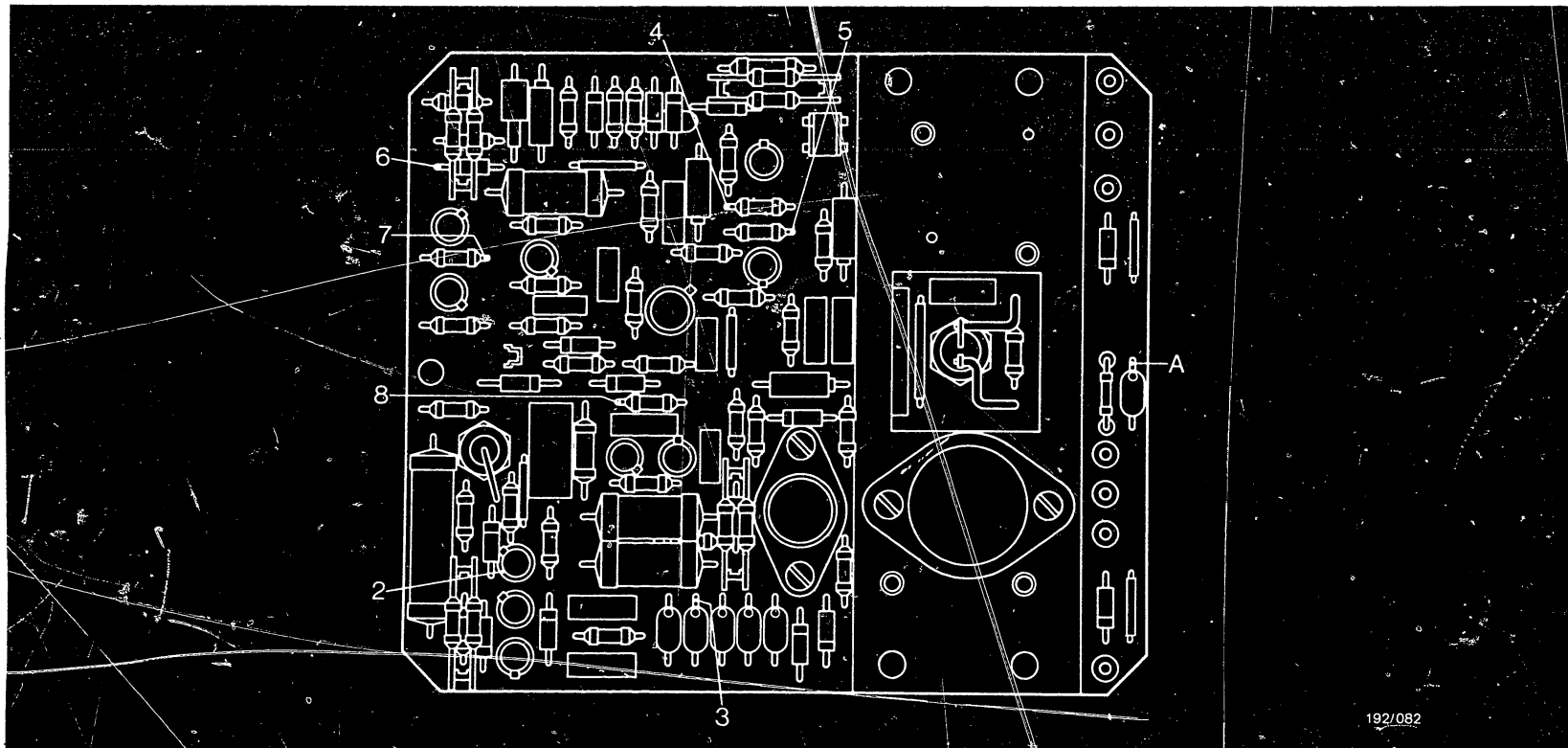

192/082

Test points for trouble-shooting on regulator 0 192 003 011
with generator and oscilloscope.

Reference potential for test points 2.8 is connection
point A:

Test point 2 = collector T 3
 Test point 3 = emitter T 13
 Test point 4 = base T 9
 Test point 5 = base T 8

Test point 6 = base T 7
 Test point 7 = base T 6
 Test point 8 = base T 10

B4

Trouble-shooting

Transistor regulator 0 192 003 011 / 012



B5

Trouble-shooting

Transistor regulator 0 192 003 011 / 012



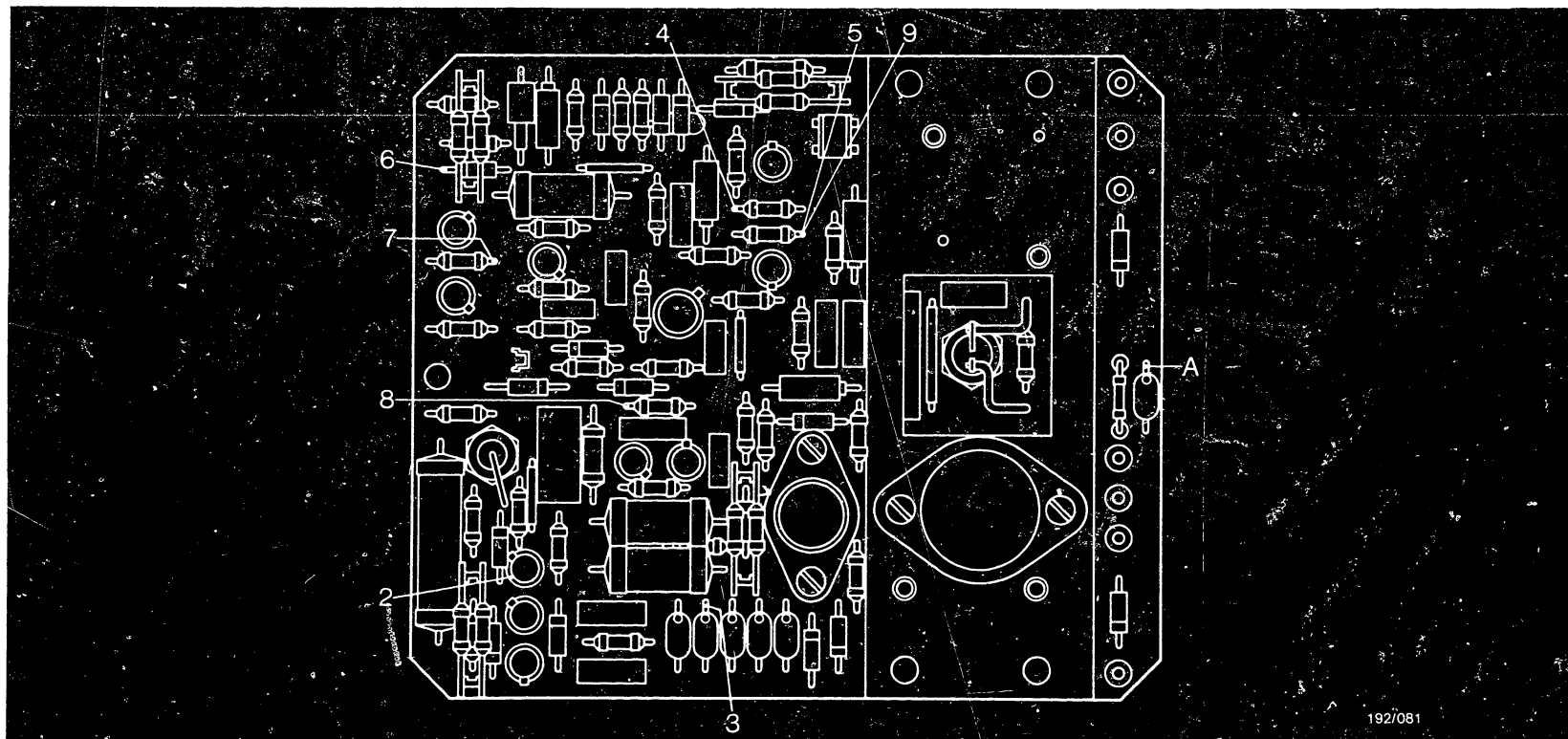

192/081

Test points for trouble-shooting on regulator 0 192 003 012
with generator and oscilloscope.

Reference potential for test points 2-9 is connection
point A:

Test point 2 = collector T 3
 Test point 3 = emitter T 13
 Test point 4 = base T 9
 Test point 5 = base T 8
 Test point 6 = base T 7

Test point 7 = base T 6
 Test point 8 = base T 10
 Test point 9 = base T 8 sensing lead connected.

B6

Trouble-shooting

Transistor regulator 0 192 003 011 / 012

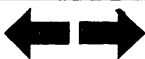

B7

Trouble-shooting

Transistor regulator 0 192 003 011 / 012

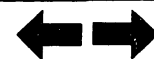

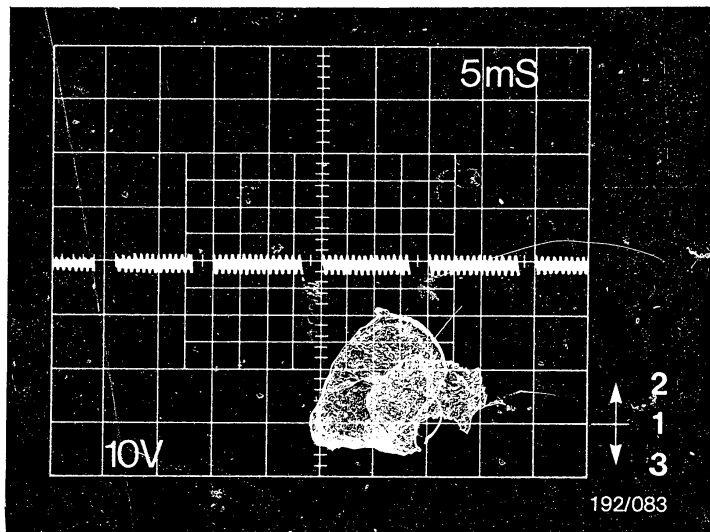

Fig. 1

O.K. oscilloscope display for test point 3 (emitter T 13)

- | | |
|-------------------------------|------------------|
| 1 = Base line on oscilloscope | } Input inverted |
| 2 = Negative | |
| 3 = Positive | |



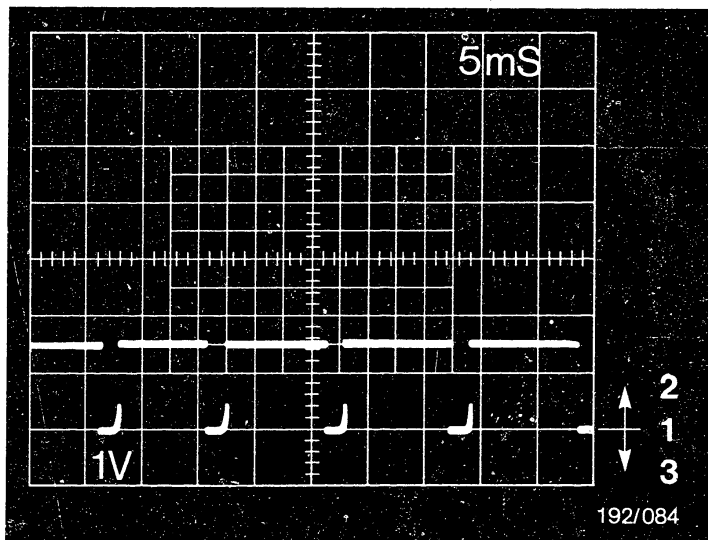

Fig. 2

O.K. Oscilloscope display for test point 4 (base T 9)

- 1 = Base line on oscilloscope
 2 = Negative } Input inverted
 3 = Positive }

B9

Trouble-shooting

Transistor regulator 0 192 003 011 / 012



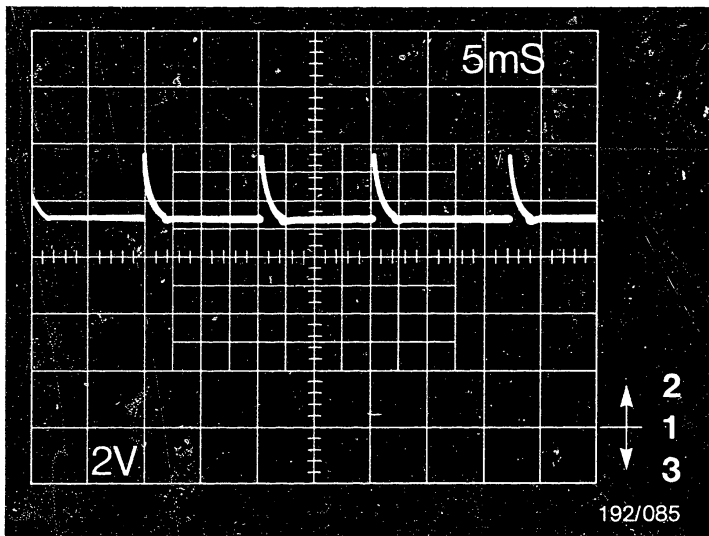

Fig. 3

O.K. oscilloscope display for test point 5 (base T 8)

- | | |
|-------------------------------|------------------|
| 1 = Base line on oscilloscope | } Input inverted |
| 2 = Negative | |
| 3 = Positive | |



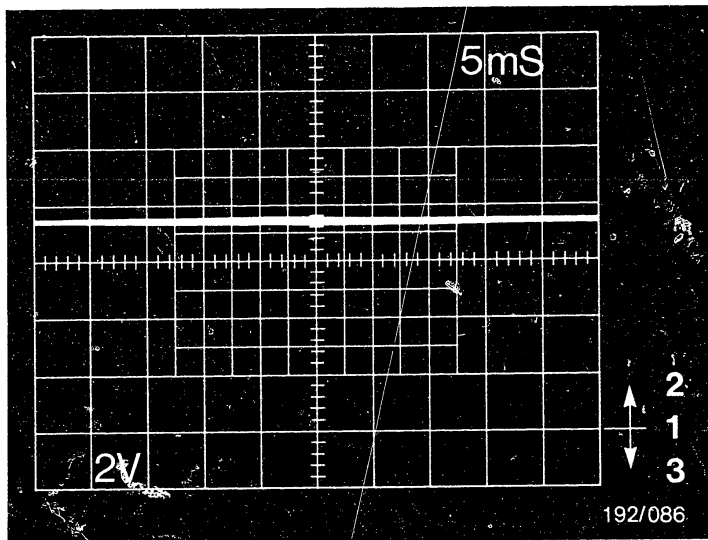

Fig. 4

O.K. oscilloscope display for test point 6 (base T 7)

- | | |
|-------------------------------|------------------|
| 1 = Base line on oscilloscope | } Input inverted |
| 2 = Negative | |
| 3 = Positive | |



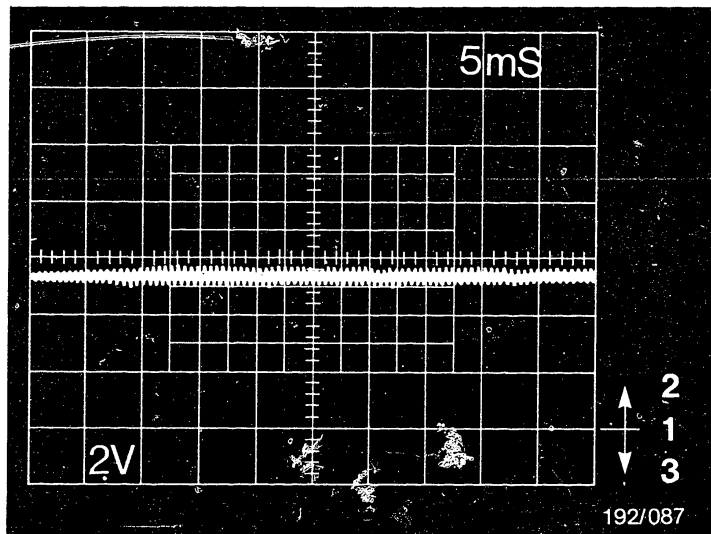

Fig. 5

O.K. oscilloscope display for test point 7 (base T 6)

- 1 = Base line on oscilloscope
 2 = Negative } Input inverted
 3 = Positive }



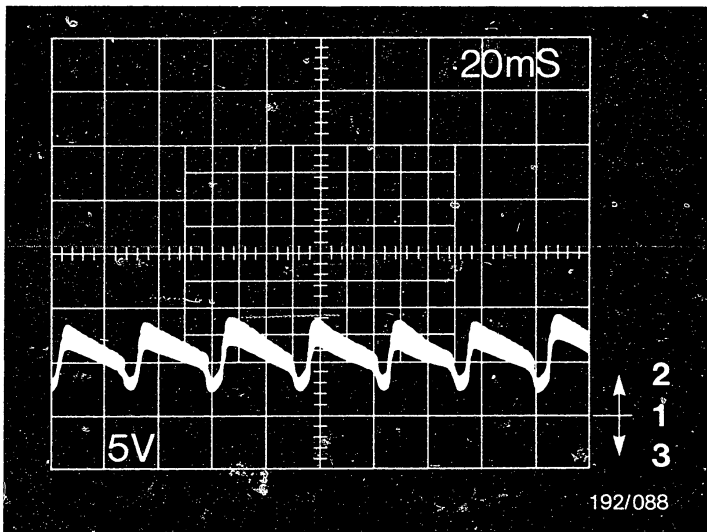

Fig. 6

O.K. oscilloscope display for test point 8 (base T 10)

- 1 = Base line on oscilloscope
 - 2 = Negative
 - 3 = Positive
- } Input inverted



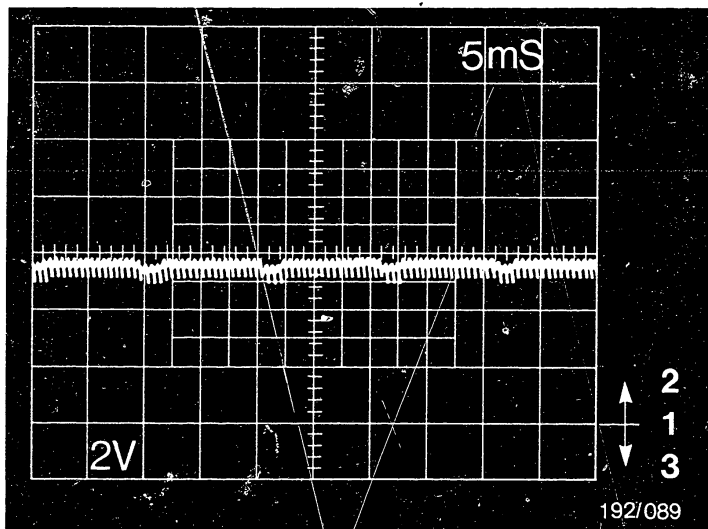
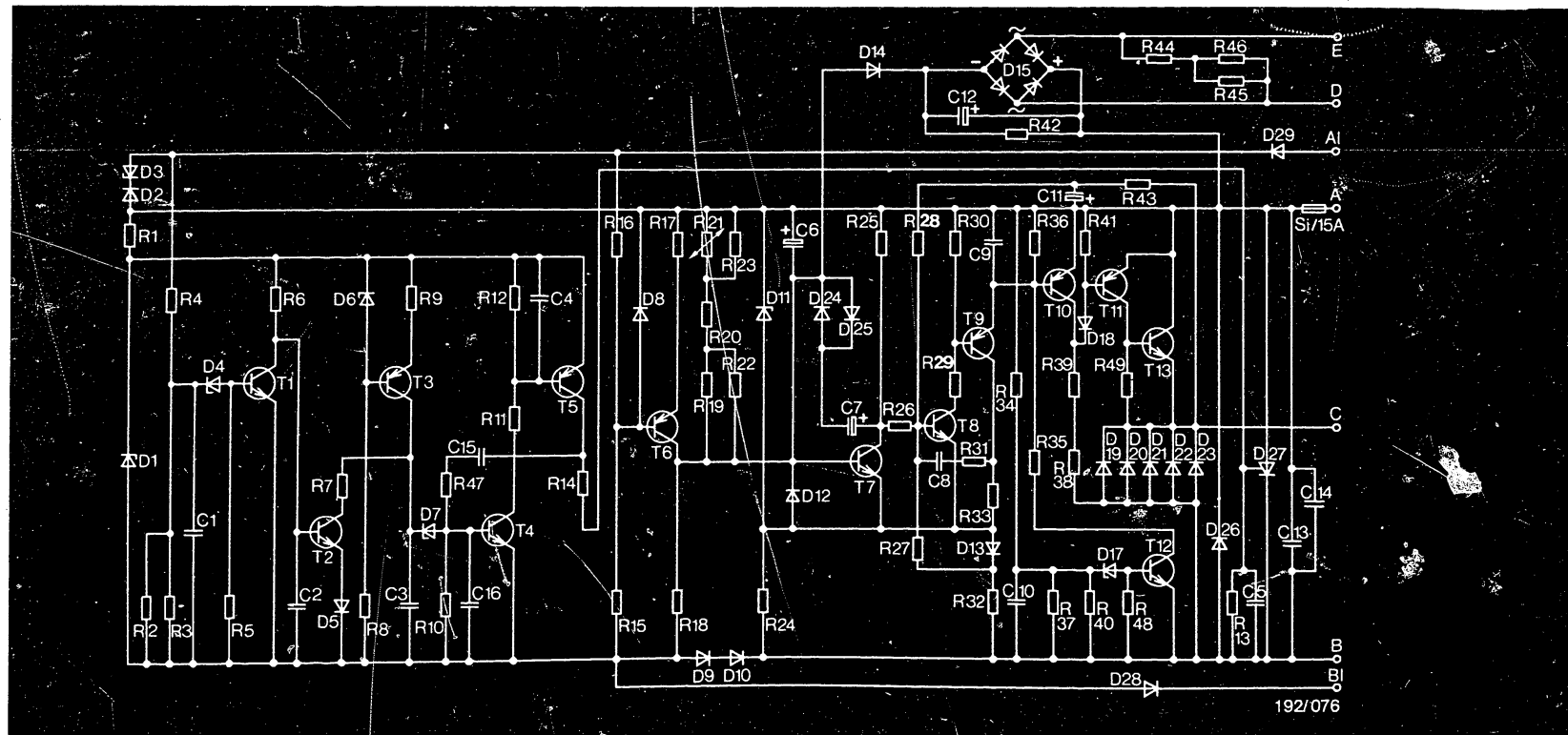

Fig. 7

O.K. oscilloscope display for test point 9 (base T 8)
Sensing lead connected

- 1 = Base line on oscilloscope
- 2 = Negative } Input inverted
- 3 = Positive }





6.4 Information on possible faults

Regulated voltage is outside tolerance

Possible faults:

Trimming incorrect

Unidirectional-breakdown diode D11 has changed its Zener voltage.

Transistor T7 has insufficient current amplification.

Lead E, D has open circuit.

Generator not excited

Safety circuit has responded, i.e. fuse S1 has blown (check cable connection between generator and regulator). Transistor T8 defective (e.g. short circuit). Transistors T9-T13, T7 defective (e.g. open circuit). Unidirectional-breakdown diode D11 has changed its Zener voltage.

B 15

Trouble-shooting

Transistor regulator 0 192 003 011 / 012



B 16

Trouble-shooting

Transistor regulator 0 192 003 011 / 012



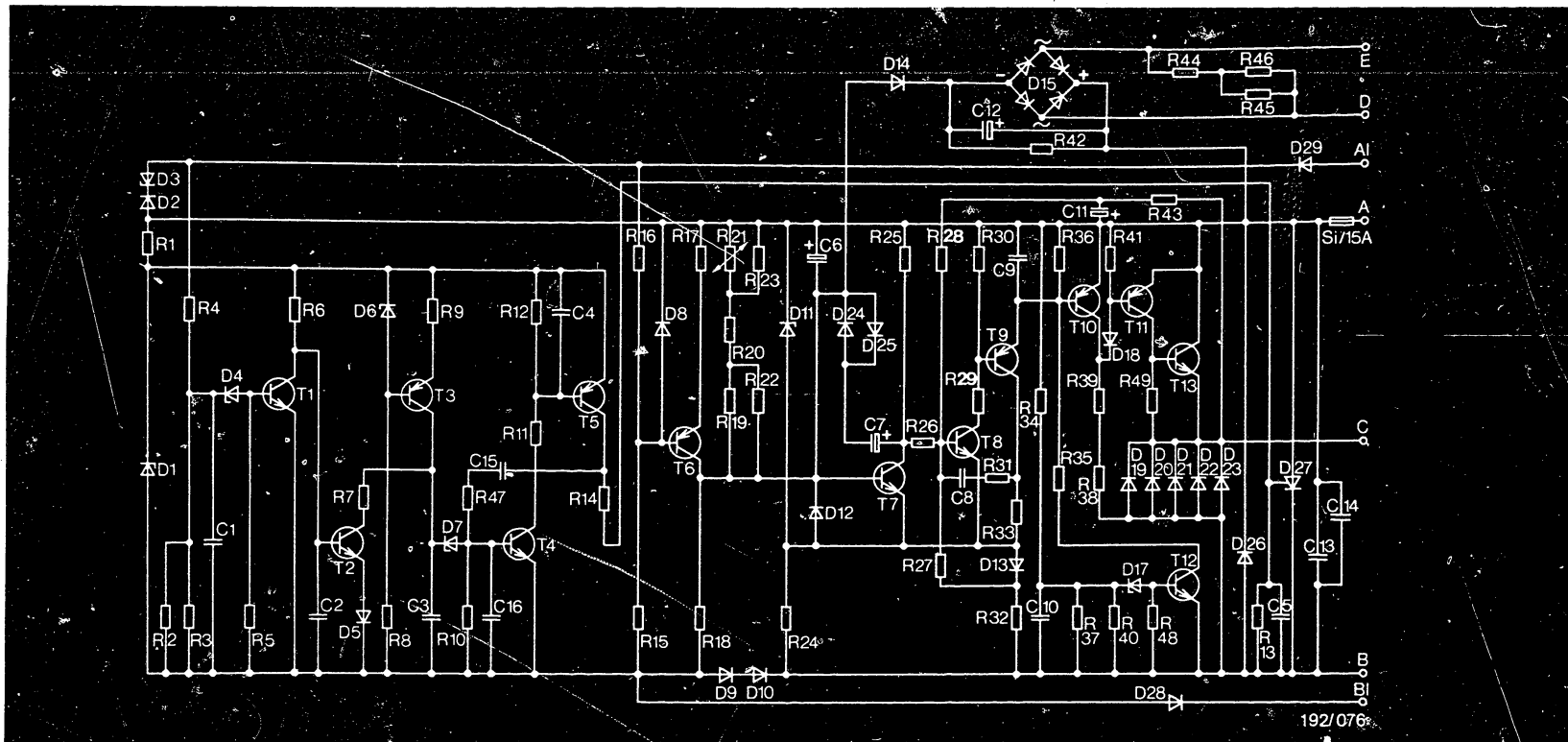

Generator fully excited, regulator not regulating

Transistors T7, T11, T13 defective (e.g. short circuit).
 Transistors T8, T9, T10, T12 defective (e.g. open circuit).
 Unidirectional-breakdown diode D11 defective (e.g. short circuit).

Generator not reaching maximum current

Diodes D14, D15 defective (e.g. short circuit).

Generator exceeding maximum current

Diodes D14, D15 defective (e.g. open circuit)

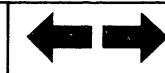

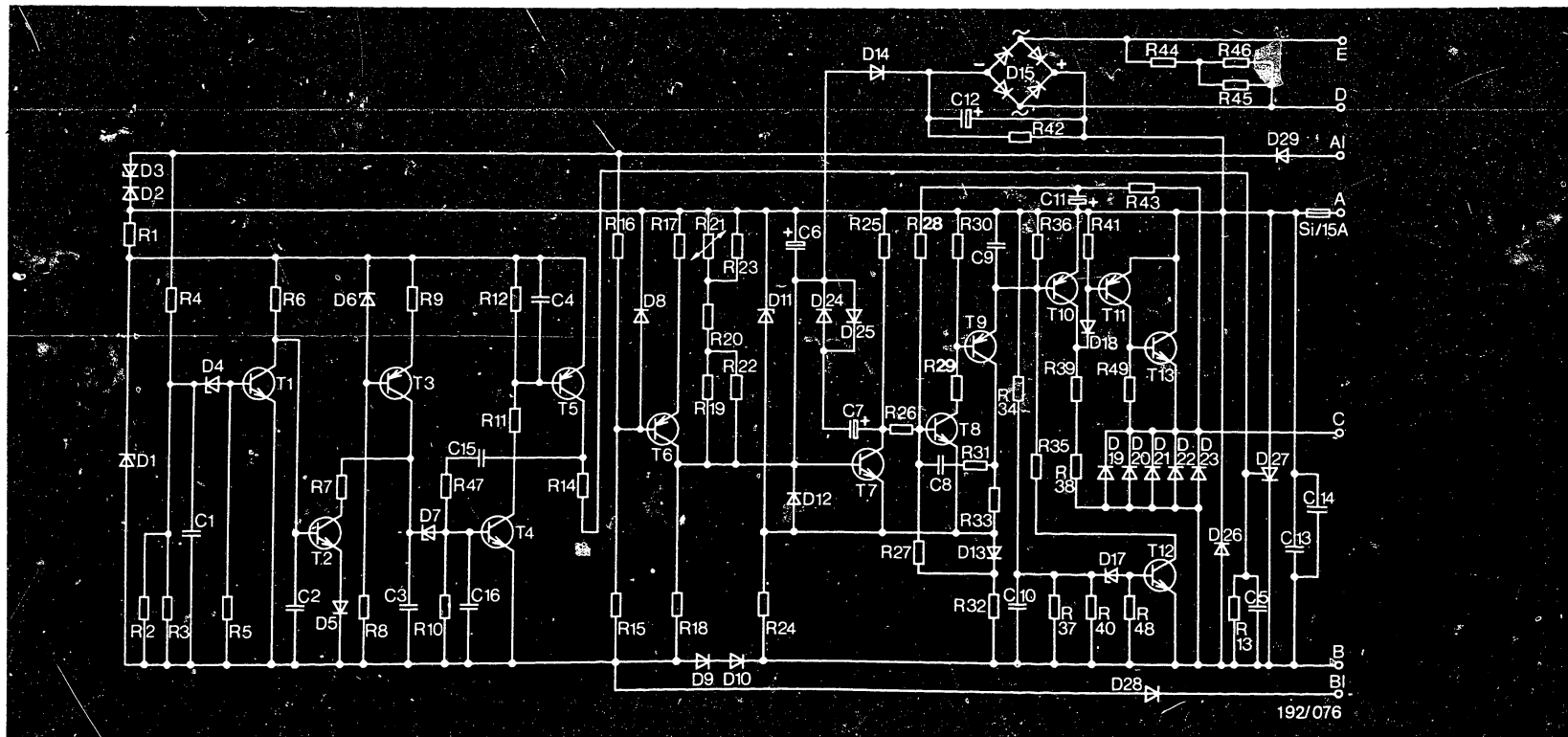

Safety circuit responds although the vehicle electrical system is in order and the generator system is firmly connected to the battery.

Possible faults:

Transistors T1, T3, T4, T5, unidirectional-breakdown diode D4, thyristor D27 defective (e.g. short circuit). Diode D5 open-circuit transistor T2 defective (e.g. open circuit).

Safety circuit responds immediately when switching on

Possible faults:

Transistors T1, T3, T4, T5, unidirectional-breakdown diode D4, D5 defective (e.g. short circuit) see above.
Transistor T2 defective (e.g. open circuit),

B 19

Trouble-shooting

Transistor regulator 0 192 003 011 / 012

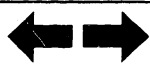

B 20

Trouble-shooting

Transistor regulator 0 192 003 011 / 012

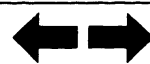

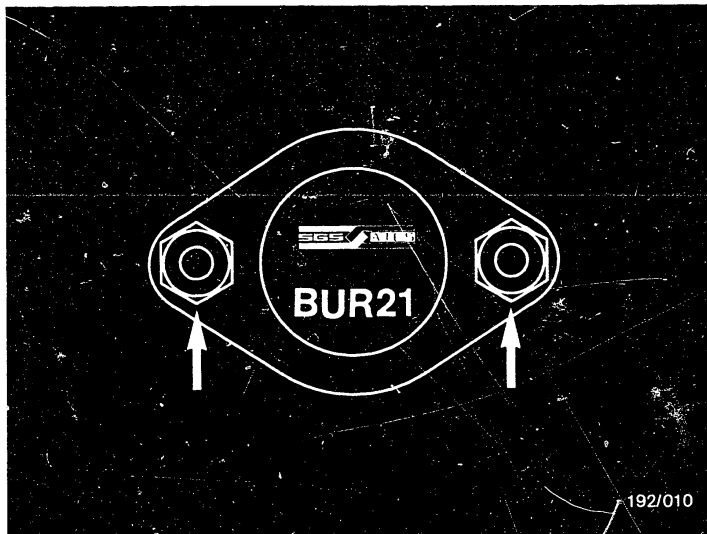

192/010

6.5 Information on replacing individual parts

Mark the leads so that the connections are not mixed up when assembling. This would cause irreparable damage to the regulator. Do not heat semiconductor devices when soldering. In order to dissipate the heat, hold the connection wire behind the solder joint with pointed pliers or tweezers. After unsoldering a defective component remove excess tin-lead solder from the holes in the printed circuit board (use an extractor). When soldering in, do not apply too much tin-lead solder.

Caution: For soldering use only colophonium tin. Under no circumstances use paste-type soldering flux.

In order to remove transistor T13, first of all unsolder the connection wires on the printed circuit board, then loosen the fastening nuts (arrow). Replace the transistor. Before installing a new transistor, coat the insulating foil with thermo-lubricant Part No.

5 942 860 003.

B21

Trouble-shooting

Transistor regulator 0 192 003 011 / 012



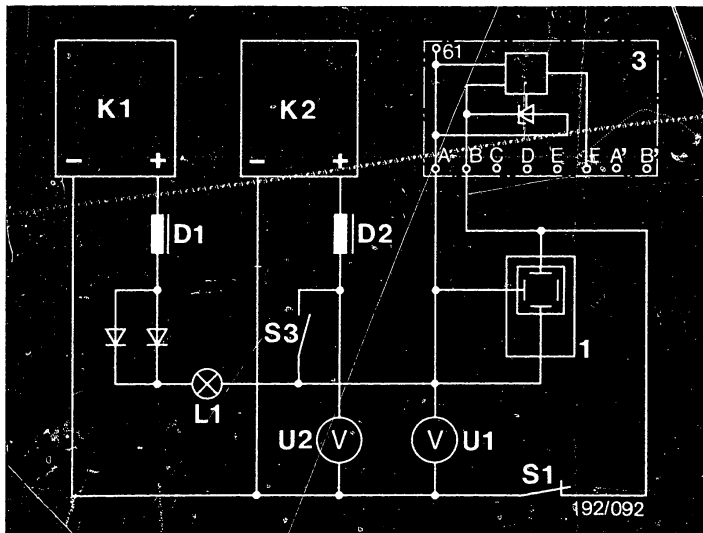

- K 1 = Voltage stabilizer 0...50 V max. 2 A
 K 2 = Voltage stabilizer 0...50 V max. 1 A
 S 1 = Non-locking switch with normally-closed contact
 S 3 = Non-locking switch with normally-open contact (bounce-free)
 L 1 = Bulb 24 V 21 W
 D 1, D 2 = Inductor L approx. 2 mH
 1 = Oscilloscope
 2 = Object under test

7. Testing the regulator

7.1 Test circuit for regulator 0 192 003 011

Construct the test circuit as shown in the diagram. Set the current limitation to 2 A at voltage stabilizer K1 and to 1 A at voltage stabilizer K2.

The test circuit is switched on using switch S1.

C1

Testing the regulator

Transistor regulator 0 192 003 011 / 012



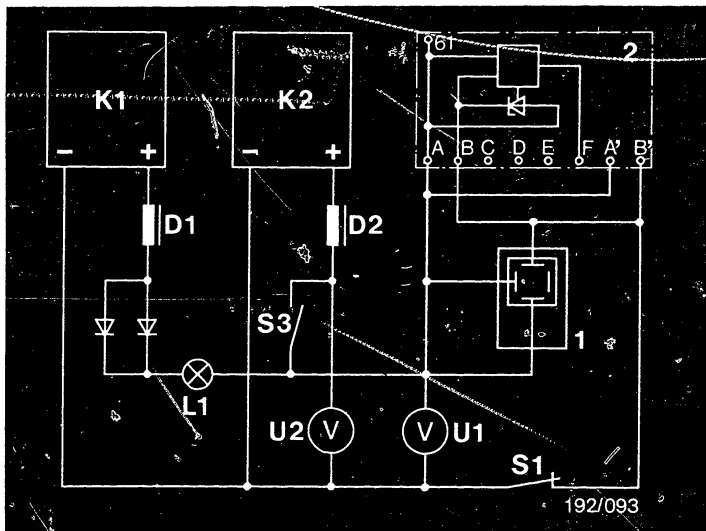

- K 1 = Voltage stabilizer 0...50 V max. 2 A
- K 2 = Voltage stabilizer 0...50 V max. 1 A
- S 1 = Non-locking switch with normally-closed contact
- S 3 = Non-locking switch with normally-open contact (bounce-free)
- L 1 = Bulb 24 V 21 W
- D 1, D 2 = Inductor L approx. 2 mH
- 1 = Oscilloscope
- 2 = Object under test

7.1.1 Test circuit for regulator 0 192 003 012

Construct the test circuit as shown in the diagram. Set the current limitation to 2 A at voltage stabilizer K1 and to 1 A at voltage stabilizer K2. The test circuit is switched on using switch S1.



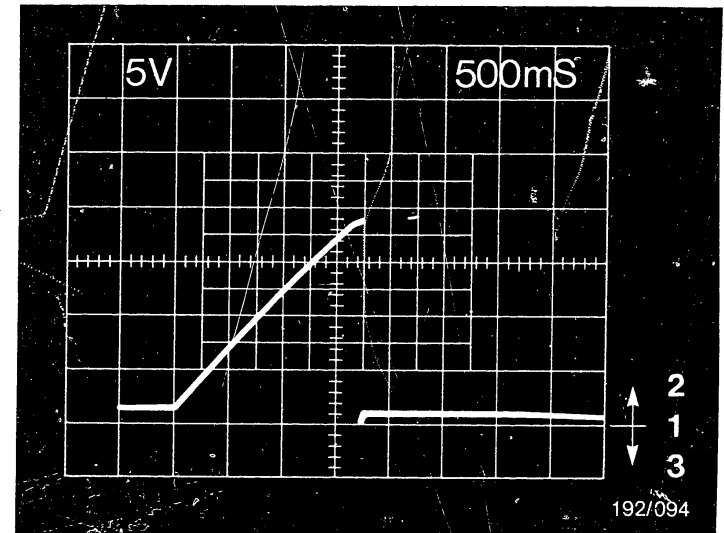
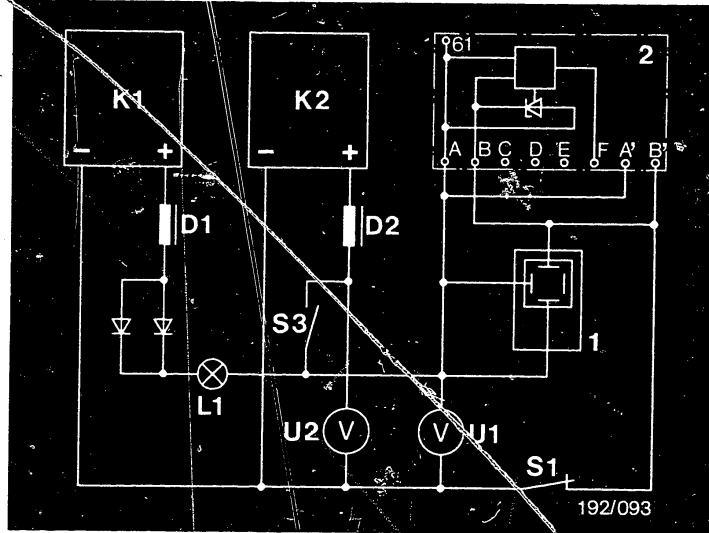

7.2.1 Testing the safety circuit on regulator
0 192 003 012 (2)

Set the voltage across voltage stabilizer K1 to U1 = 27.9...28.1 V. Set the test voltage across voltage stabilizer K2 to U2 = 34.9...35.1 V. The time delay between switching on non-locking switch S3 and the dropping off of voltage U1 (visually indicated by bulb L1 lighting up) can be read off on the oscilloscope screen (1). The rated value of the time delay is 1.6...2 sec. After checking the safety circuit the thyristor is reset again by depressing switch S1.

O.K. oscilloscope display for test point 2
(collector T3)

- 1 = Base line
 - 2 = Positive
 - 3 = Negative
- } Input

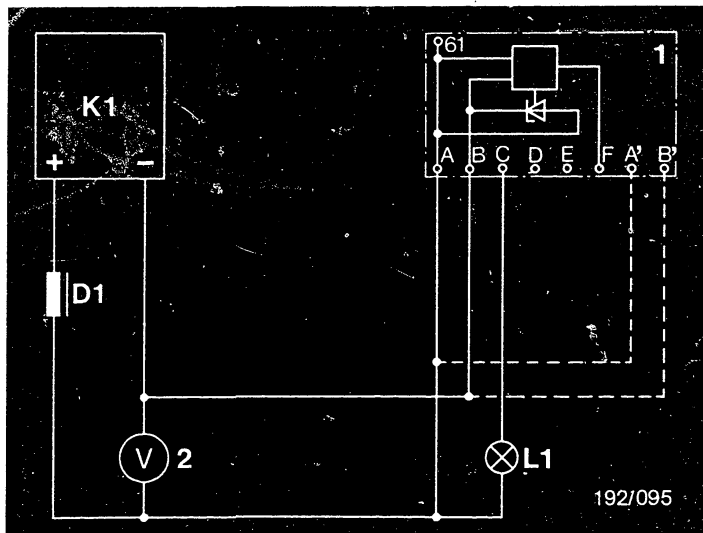

- K 1 = Voltage stabilizer 0...50 V max. 2 A
 L 1 = Bulb 24 V 4 W
 D 1 = Inductor L approx. 2 mH
 1 = Object under test with and without (broken lines) sensing lead
 2 = Measuring instrument

7.3 Testing the blocking circuit

Short-circuit trimmers R19/R22 on printed circuit board. Connect the regulator to the test circuit as shown in the diagram.

Increase the voltage at the voltage stabilizer until the bulb goes out.

Read off the voltage on the measuring instrument.

Rated value 31.5...32.0 V for regulator 0 192 003 011/012
 Maximum measuring time ≤ 0.5 sec.

C7

Testing the regulator

Transistor regulator 0 192 003 011 / 012



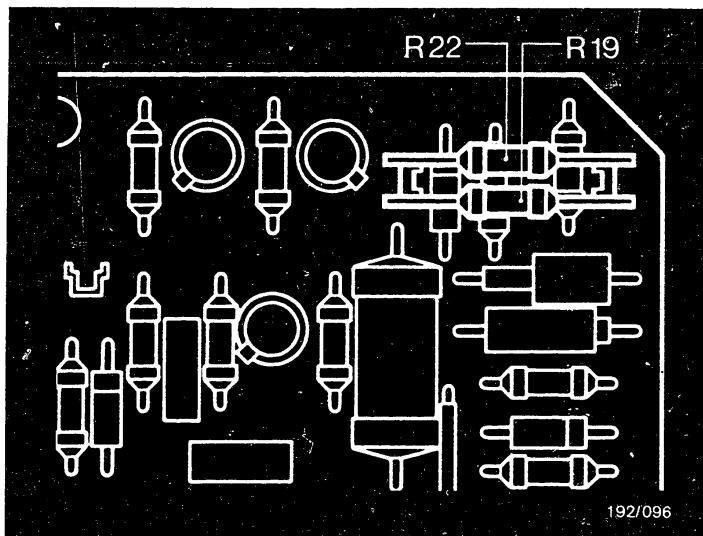

192/096

7.4 Testing the regulated voltage

Test the regulated voltage according to the following values:

Transistor regulator 0 192 003 011

Speed min ⁻¹	Load current (A)	Regulated voltage (V)	Temperature (°C)
2900...3100	25...35	28.4...28.6	24...26

Transistor regulator 0 192 003 012

Speed min ⁻¹	Load current (A)	Regulated voltage (V)	Temperature (°C)
2900...3100	25...35	29.5...29.6	24...26

C8

Testing the regulator

Transistor regulator 0 192 003 011 / 012



7.5 Testing the current limitation

At a generator speed $N_G = 3000 \text{ min}^{-1}$ the generator current must be as follows:

Regulator 0 192 003 011

Regulated voltage	26.5...27.5 V
Generator current	150...155 A

Regulator 0 192 003 012

Regulated voltage	27...28 V
Generator current	130...135 A



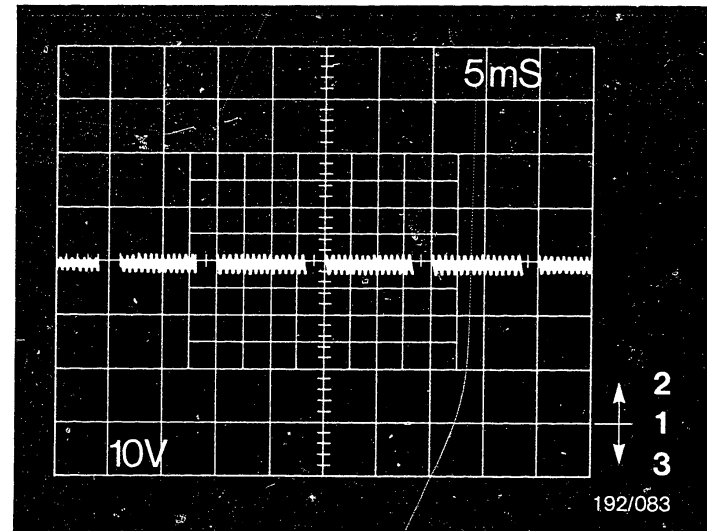
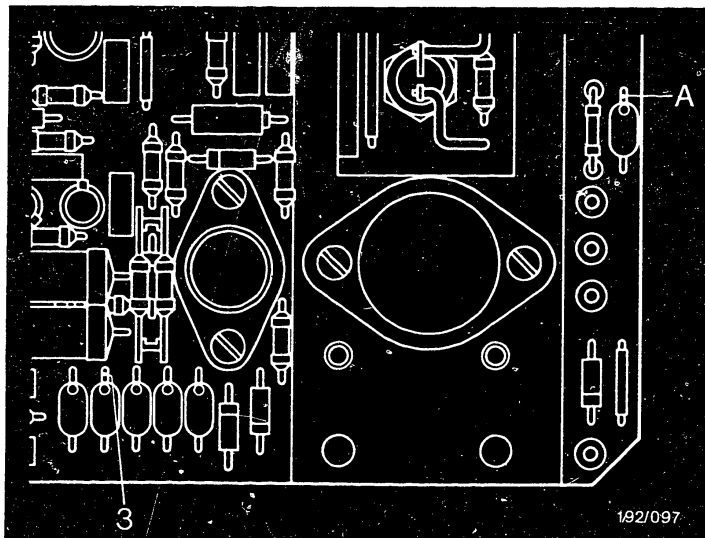

8. Adjusting the regulator

Before adjusting the regulator it is useful to record an oscilloscope display at test point 3 (with generator speed 3000 min^{-1} and 30 A load) and to compare it with the oscilloscope display shown above. The regulator can only be properly adjusted if it is absolutely O.K. electrically.

Caution: Test the regulator and generator only with the battery connected in parallel. Switch off the loading resistor only with the battery connected. Do not switch off the battery until the generator has stopped.

O.K. oscilloscope display for test point 3 (emitter T13)

- 1 = Base line on oscilloscope
- 2 = Negative, } Input inverted
- 3 = Positive }

C10

Adjusting the regulator

Transistor regulator 0 192 003 011 / 012



C11

Adjusting the regulator

Transistor regulator 0 192 003 011 / 012



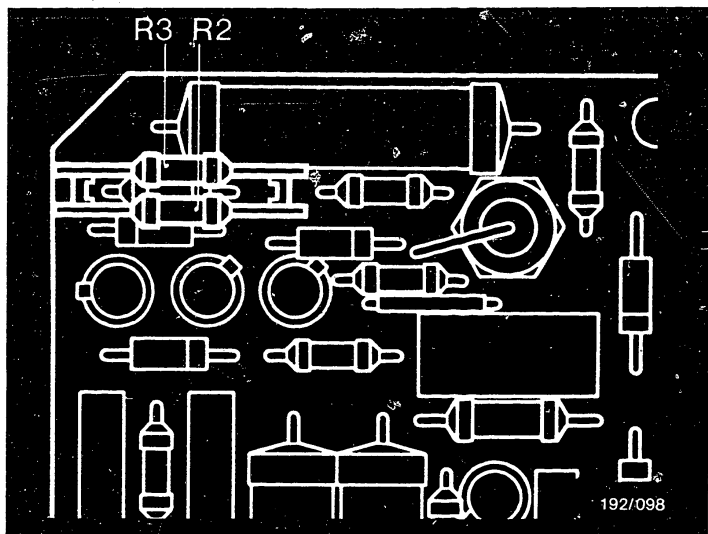

8. Adjusting the regulator

8.1 Adjusting the safety circuit

The safety circuit is trimmed with resistors R2/R3. Short-circuit all trimming points apart from R2/R3. Connect a resistance decade to trimming point R2/R3. Set the resistance decade to 0Ω .

Voltage reading on measuring instrument approx. 1 V. Increase the resistance at the resistance decade. When the response voltage is reached the voltage on the measuring instrument begins to rise. Solder a resistor into the circuit having the value which was set on the resistance decade.

The setting of the safety circuit is checked by changing the response voltage.

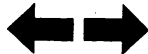

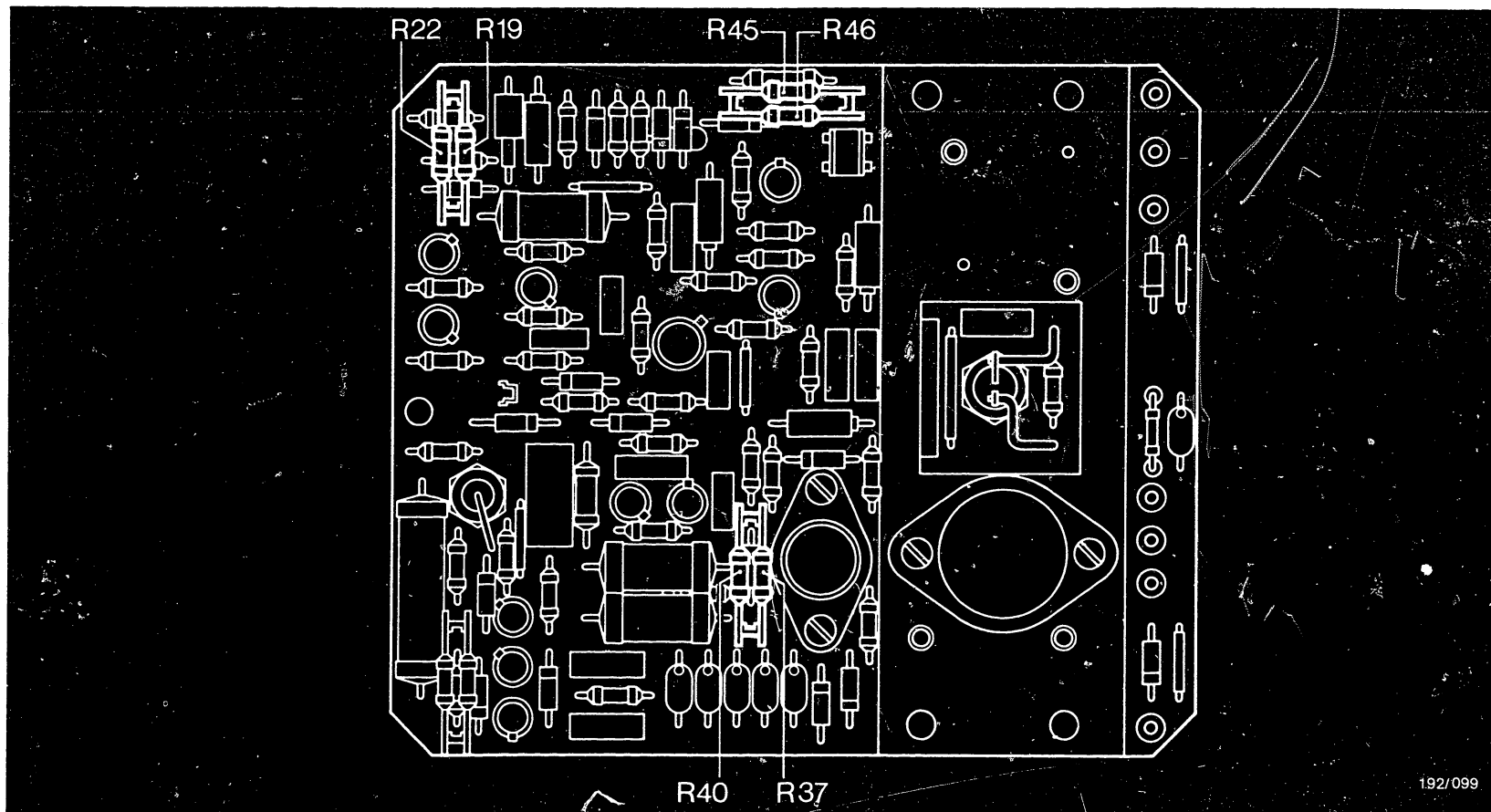

192/099

8.2 Adjusting the blocking circuit

Short-circuit trimming resistors R19/R22 and R45/46. Connect a resistance decade to trimming point R37/R40. Set the resistance decade to approx. 10 k Ω . Reduce the decade resistance until a voltage of 31.5... 32.0 V is indicated on the measuring instrument with 30 A load and 3000 min⁻¹ generator speed. Solder a resistor into the circuit having the value which was

indicated on the resistance decade and test once again.

C13

Adjusting the regulator

Transistor regulator 0 192 003 011 / 012

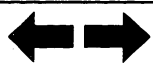

C14

Adjusting the regulator

Transistor regulator 0 192 003 011 / 012

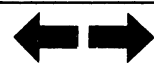

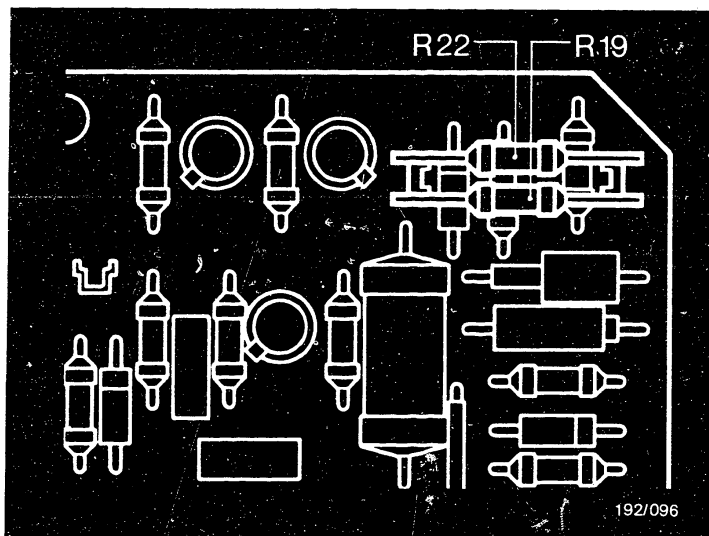

8.3 Adjusting the regulated voltage

Remove the jumper from trimming point R19/R22. Change the resistance at the resistance decade until the measuring instrument indicates the following voltage:

Regulator 0 192 003 011 28.4...28.6 V

Regulator 0 192 003 012 29.5...29.6 V

Solder a resistor into the circuit having the value which was set on the resistance decade.
Check the regulated voltage.

C15

Adjusting the regulator
Transistor regulator 0 192 003 011 / 012



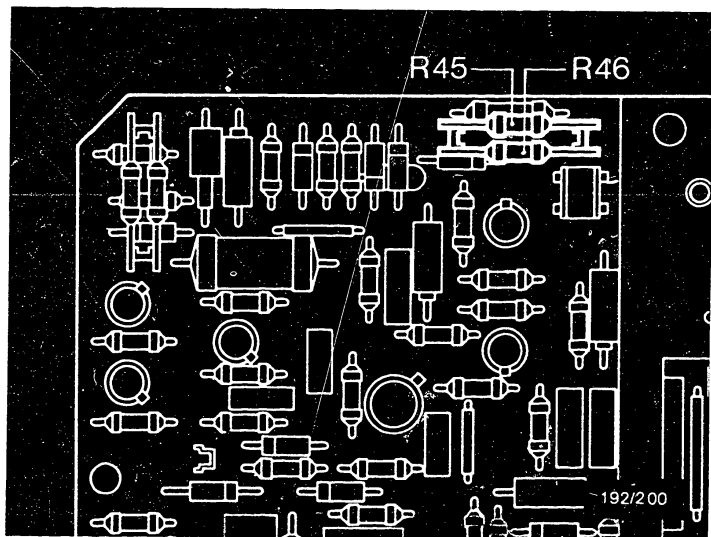

8.4 Adjusting the current limitation

Remove the jumper from trimming point R45/R46. Connect a resistance decade to the trimming point. Change the resistance at the resistance decade so that the values given below are reached with the set load (set with load resistor). Then solder in a resistor having the value indicated on the resistance decade. Check the current regulation.

Speed min ⁻¹	Regulated voltage with current limitation (V)	Current regu- lator cut-in (A)	Tempera- ture °C
Transistor regulator 0 192 003 011			
3000	26.5...27.5	150...155	24...26
Transistor regulator 0 192 003 012			
3000	27.0...28.0	130...135	24...26

C16

Adjusting the regulator

Transistor regulator 0 192 003 011 / 012



Table of contents

<u>Section</u>	<u>Coordinate</u>
Structure of microfiche	A 1
1. Test specifications	A 2
2. Test equipment, lubricants	A 4
3. Type code	A 5
4. Internal circuit diagrams	A 6
5. Functional description	A 10
5.1 Safety circuit	A 10
5.2 Regulated voltage	A 12
5.3 Regulated frequency	A 16
5.4 Blocking circuit	A 18
6. Trouble-shooting	B 1
6.1 Visual examination	B 1
6.2 Insulation testing	B 1
6.3 Trouble-shooting with oscilloscope	B 2
6.4 Information on possible faults	B 15
6.5 Information on replacing individual parts	B 21
7. Testing the regulator	C 1
7.1 Testing the test circuit for regulator	C 1
7.2 Testing the safety circuit	C 3
7.3 Testing the blocking circuit	C 7
7.4 Testing the regulated voltage	C 8
7.5 Testing the current limitation	C 9



Table of contents

<u>Section</u>	<u>Coordinate</u>
8. Adjusting the regulator	C 10
8.1 Adjusting the safety circuit	C 12
8.2 Adjusting the blocking circuit	C 13
8.3 Adjusting the regulated voltage	C 15
8.4 Adjusting the current limitation	C 16

